

# ROMAN SHADES

LIFT SYSTEMS: CONTINUOUS CORD LOOP | MOTORIZATION



The difficulty level of this installation is ranked at **Level 1**. *A piece of cake!*

If you have questions or get stuck, call our Customer Care Team at 888-685-1735, or email [info@selectblindsCanada.ca](mailto:info@selectblindsCanada.ca)

## HARDWARE AND PARTS INCLUDED

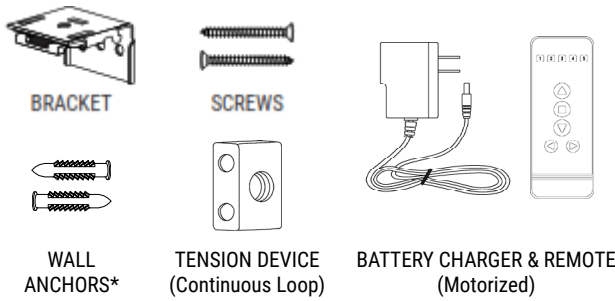

\*Recommended if mounting into hollow drywall.

## TOOLS REQUIRED

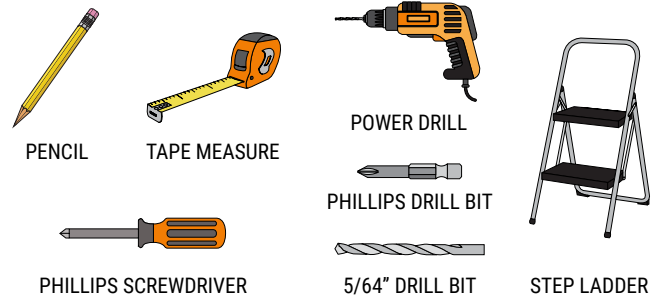

## 1. MOUNTING THE BRACKETS

**NOTE:** Before installing an inside mount motorized shade, you need to first attach the battery pack to the backside of the headrail.

**Figure A:** Slide the two plastic clips into place in the groove, from the side of the battery pack.

**Figure B:** Clip the motor cable into the battery pack. Be sure the antenna cable is positioned away from the headrail, and out of contact with anything metal.

**TIP:** The back of each bottom rail should have a tag with a number. This indicates the channel and remote that the shade is pre-programmed to.

### INSIDE MOUNT

1. Measure 2" - 4" in from each side of the window frame, and mark once with a pencil for your outer brackets. The front of the bracket will face out from the window, and the back of it will hang down parallel to the window.

**NOTE:** Leave marks for any additional brackets you need, evenly spaced between your first two marks. If using your own screws instead of those provided, be sure to pre-drill a small hole with a 5/64" drill bit before the final screws go in to attach brackets.

2. Center the brackets over your marks, and set them back until the front of the bracket meets the edge of your window. Mark through the top hole in the bracket with your pencil. This is where your screws will go.

3. Align each bracket with your screw holes and drill the screws securely into place.

\*If you are using wall anchors, pre-drill with a 1/4" bit instead, and tap the wall anchors into the holes with a hammer before drilling in the screws.

Figure A

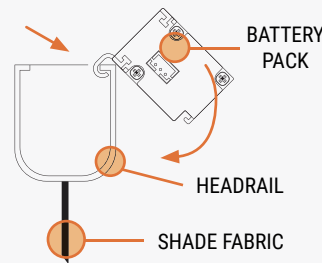
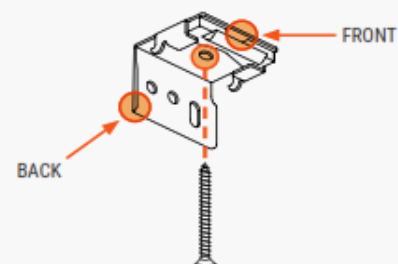
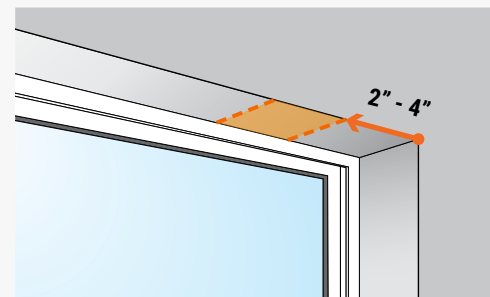
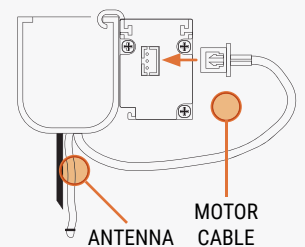

Figure B



## OUTSIDE MOUNT

1. Measure 2" - 4" in from each side of the window frame. From here, measure upward another 2" - 4", and make a pencil mark.

**NOTE:** Leave marks for any additional brackets you need, evenly spaced between your first two marks and at the same height. If using your own screws instead of those provided, be sure to pre-drill a small hole with a 5/64" drill bit before the final screws go in to attach brackets.

2. Center the top edge of the brackets on your marks. With your pencil, mark through the back holes of the bracket. This is where your screws will go.

3. Align each bracket with your screw holes and drill the screws securely into place.

\*If you are using wall anchors, pre-drill with a 1/4" bit instead, and tap the wall anchors into the holes with a hammer before drilling in the screws.

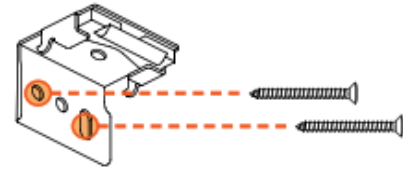
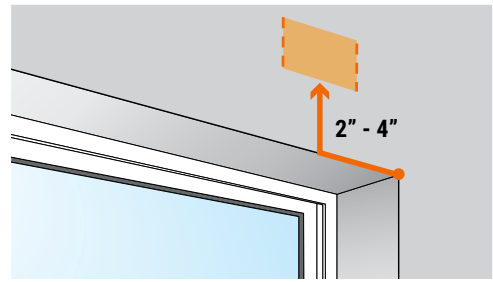

## 2. ATTACHING THE SHADE

### INSIDE AND OUTSIDE MOUNT

**NOTE:** For outside mount, use your level to check that the brackets are straight before you proceed.

1. With the front of the shade facing you, and holding it at a slight downward angle, rest the lip of the headrail against the movable tab in each of the brackets. Then gently push it toward the back of the brackets, while also straightening the rail, until the hooks attach to the back lip of the headrail.

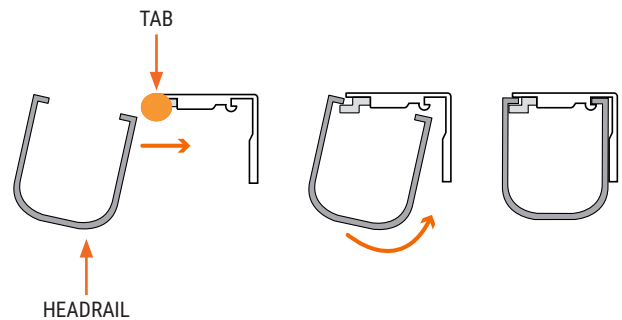

2. **IMPORTANT:** Please ensure that you fully close the headrail by attaching the headrail fabric together with the hook-and-loop fastening strip.

## 3. MOUNTING THE TENSION DEVICE

### CONTINUOUS CORD LOOP SHADES (NOT AVAILABLE IN CANADA)

**NOTE:** The cord tension device, also known as the "chain tensioner," is used to help protect pets and young children from a potential choking hazard. If there is plastic or any protective bands on the chain, remove them before proceeding.

1. Raise your shade fully so it's out of the way.

2. Pinch the ends of the tensioner together to release the grip on the chain, then pull the tensioner to the bottom of the chain loop.

3. While keeping the chain pulled tightly, place the tensioner against the inside of the window or on the wall, moving it up about 1/8 of an inch. The goal is to make the chain taut but just slightly loose for smooth operation.

4. Holding the tensioner in place, mark the two screw holes with your pencil. Move the chain away and use the marks to pre-drill your screw holes with a 5/64" drill bit.

5. Align the holes in the tensioner with the pre-drilled holes and fasten the screws, being careful NOT to over-tighten the screws.

6. To use your shade, simply pull the front of the chain to raise it, and pull the back of the chain to lower it.

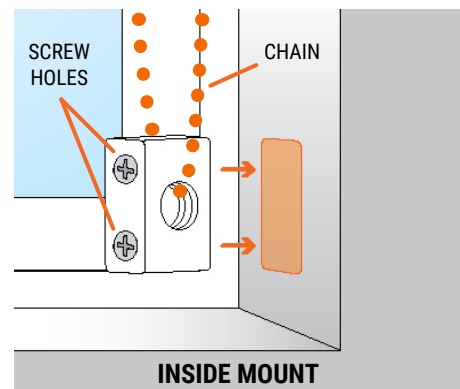

INSIDE MOUNT

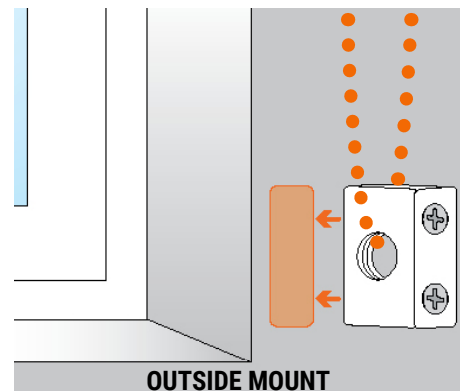

OUTSIDE MOUNT

## 4. PROGRAMMING AND USING YOUR REMOTE

### MOTORIZED ROMAN SHADES

**WARNING:** DO NOT attempt to raise or lower your motorized shade with your hands. This may cause permanent damage to the motor, and other components in the headrail, which may not be covered under your warranty.

Your shade's motor and remote(s) are pre-programmed at the factory, and are ready to use once the shade is installed. Look for the tag with two numbers on the back of each bottom rail. This indicates which channel and remote your shade is programmed to.

All you have to do is install the battery in the remote. Open the battery compartment at the bottom of the remote and insert the lithium battery into the round slot, positive side up. Slide the battery cover back onto the remote.

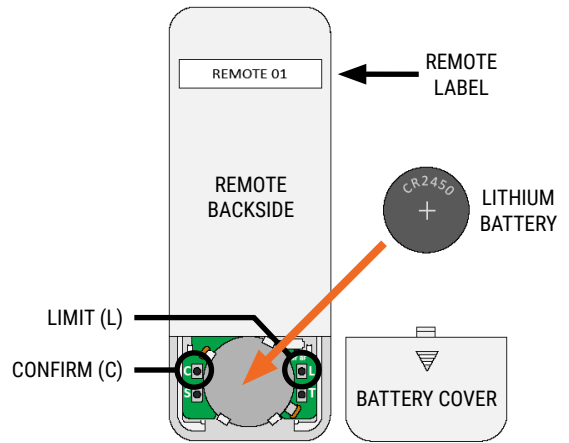

### MOUNTING BATTERY PACK

For 1) outside mount and for 2) inside mount with a shallow windowsill, you won't have room behind the headrail to attach the battery pack. You can either 1) attach the battery pack to the wall near the window, or 2) vertically inside the shallow windowsill, below the headrail, and as far back as possible. Note: Be sure your placement of the battery pack allows for uninterrupted operation of your shade and window.

#### 1. To attach battery pack for outside mount:

The most important thing to remember is to use a pencil and a level to make sure your mounting clips are aligned when you attach them to the wall. Slide the battery pack into place on the clips when ready.

#### 2. To attach battery pack for shallow inside mount:

With a pencil and a level, make sure the mounting clips are aligned vertically when you attach them inside the windowsill, as far back as possible toward the glass, so as not to interfere with the shade's operation. Slide the battery pack into place on the clips when ready.

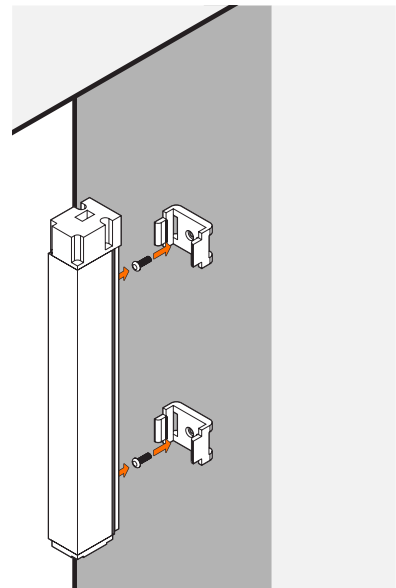

### HOW TO USE THE REMOTE

Press and hold the **Down** button to lower the shade. You can release when the shade begins lowering.

Press and hold the **Up** button to raise the shade. You can release when the shade begins raising.

Press the **Stop** button to halt the up or down movement. If you later choose to program a favorite position, holding the **Stop** button will automatically lift or lower the shade to this position.

Choose a channel by pressing the **Channel Increase** and **Channel Decrease** buttons. The **Channel Display** at the top of the remote will illuminate the channel you are currently on.

To operate all your shades at the same time, set the remote to Channel 5, and then press the **Channel Increase** button. This will illuminate all the **Channel Display** lights, which activates motors on all channels.

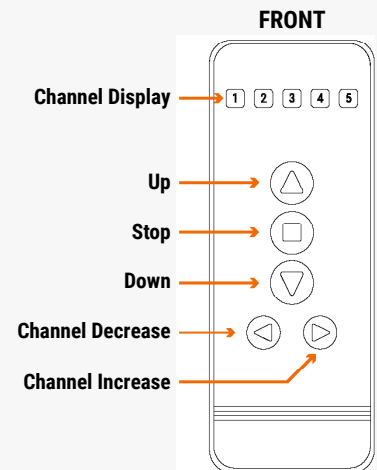

## PAIRING THE REMOTE WITH A MOTOR

**NOTE:** The factory pairs each of your shades to the remote. The following steps are only necessary if you want to change how the channels are configured, or if you are adding a new shade to a remote already in use.

1. Disconnect the motor cable from the battery.
2. Set the remote to whichever channel you want to program the shade to.
3. Both parts of this step must be completed **within three seconds**. If you don't succeed, repeat this step a bit faster, or have someone assist you.
  - A. Plug the motor cable back into the battery.
  - B. With your finger, quickly press and hold the **Confirm (C)** button on the back of the remote.

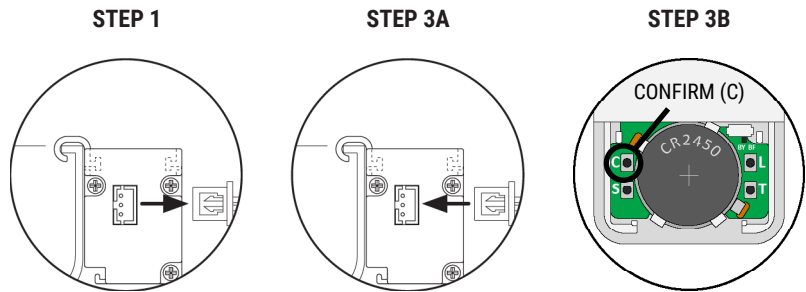

When the shade jogs (a quick up and down movement), the remote is paired to the channel you've chosen.

## DELETING A CHANNEL FROM THE MOTOR

**NOTE:** Removing a remote or channel from a shade does not delete or reset the limit settings.

1. Select the channel you'd like to disconnect the shade from.
2. Press the **Confirm** button repeatedly (about 3 - 7 presses); the shade will jog three individual times. After the third jog, your channel is removed from the shade, and ready to be assigned to a new channel or a new remote.

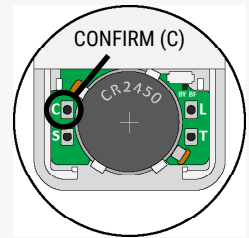

## ADJUSTING UPPER AND LOWER LIMITS

**NOTE:** The upper and lower limits are already set-up at the factory, so the following steps are only necessary if you want to change how these settings are configured. Both limits must be reprogrammed in these instructions.

1. Start with the shade fully raised. For a few seconds, press and hold the **Limit** button until the shade jogs. Your motor is now in programming mode.
2. Press **Down** to lower the shade until it's almost to the bottom, then press **Stop**. From here, repeatedly press **Down** to lower the shade slowly.
3. When the shade reaches the desired bottom position, flip the remote and use your pen to press the **Confirm** button. The shade will jog to acknowledge that your lower limit is now set, but the motor is still in programming mode.
4. Press **Up** to raise the shade until it's almost to the top, then press **Stop**. From here, repeatedly press **Up** to raise the shade slowly.
5. When the shade reaches the desired top position, flip the remote and use your pen to press the **Confirm** button. The shade will jog to acknowledge that your upper limit is now set, and the motor will automatically exit programming mode.

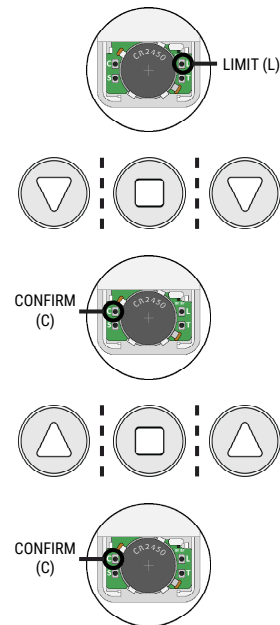

## SETTING A FAVORITE POSITION (OPTIONAL)

1. Start with the shade raised fully, then press the **Down** button for the shade to lower.
2. Press **Stop** at the position you wish to save as your favorite.
3. Simultaneously press and hold the **Limit** button and the **Up** button, until the shade jogs. Your favorite position is now set. If you wish to change the favorite position, simply repeat these steps again.

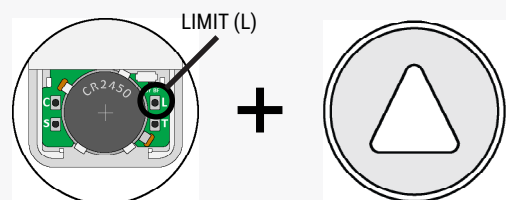

## CLEANING INSTRUCTIONS

**NOTE:** All fabrics are different and some may be easier to clean than others. We recommend cleaning your shades as often as once a month. Here are some general guidelines on how to do so:

1. For regular maintenance, use a duster or a vacuum with a brush attachment and run it over the front and back of the shade.
2. To spot clean stains, use a damp rag with a very mild, gentle detergent or soap. Dab at the affected spots; do NOT rub! Let the dampened area air-dry and repeat as necessary.
3. If your roman shade has wrinkles, you can use a basic steamer to remove them. Hold the steamer roughly six inches away from the fabric and wave the steamer back and forth over the wrinkled areas.

## WARRANTY AND REPLACEMENT

To learn more about our product warranties, please visit: <https://www.selectblindscanada.ca/warranty>

For replacement parts, and/or to file a warranty claim for a product that is damaged, defective, or missing parts, please call our Customer Care Team at 888-685-1735, or email [info@selectblindscanada.ca](mailto:info@selectblindscanada.ca).

# WARNING

**STRANGULATION HAZARD** — Young children can be strangled by cords. Immediately remove this product if a cord longer than 22 cm or a loop exceeding 44 cm around becomes accessible.

# ROMAN SHADES

## LIFT SYSTEMS: CORDLESS LIFT



The difficulty level of this installation is ranked at **Level 1**. *A piece of cake!*

If you have questions or get stuck, call our Customer Care Team at 888-685-1735, or email [info@selectblindsCanada.ca](mailto:info@selectblindsCanada.ca)

### HARDWARE AND PARTS INCLUDED

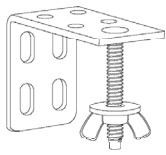

BRACKET WITH WINGNUT



SCREWS



WALL ANCHORS\*

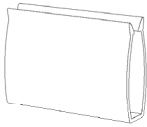

CORDLESS HANDLE

\*Recommended if mounting into hollow drywall.

### TOOLS REQUIRED



PENCIL

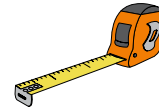

TAPE MEASURE



POWER DRILL



5/64" DRILL BIT



PHILLIPS SCREWDRIVER



PHILLIPS DRILL BIT



LEVEL



STEP LADDER

## 1. MOUNTING THE BRACKETS

**NOTE:** Cordless shades have pre-drilled holes in the top of the headrail. You will use these holes as a guide for your bracket placement. If using your own screws instead of those provided, be sure to pre-drill a small hole with a 5/64" drill bit before the final screws go in to attach brackets.

### INSIDE MOUNT

1. Grasp the shade by the headrail and hold it up inside the top of the window. Set it back until the front of the shade is flush with the wall. Hold the shade in place, and with a pencil, make a mark through each hole in the headrail. Set the shade aside.
2. Take a bracket and center the drop-bolt over each mark. Use the holes in the top of the bracket to mark where your two screws will go.
3. Align the brackets with the holes, and use a Phillips drill bit to securely fasten the screws.

PRE-DRILLED HOLES

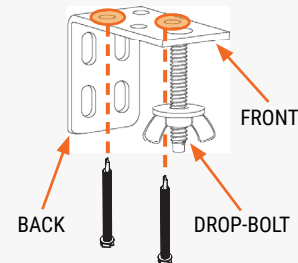
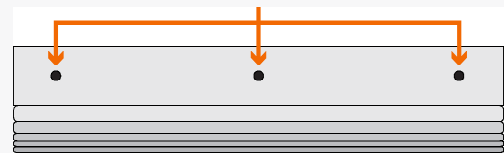

### OUTSIDE MOUNT

**NOTE:** If using your own screws instead of those provided, be sure to pre-drill a small hole with a 5/64" drill bit before the final screws go in to attach brackets.

1. Center and hold the headrail at least two inches above the window. While keeping the shade level, make a small line with your pencil just above each of the pre-drilled holes in the headrail. Set the shade aside.
2. Align the top edge of a bracket along each mark, and use the holes in the back of the bracket to mark where your two screws will go.
3. Align the brackets with the holes, and use a Phillips drill bit to fasten the screws in place.

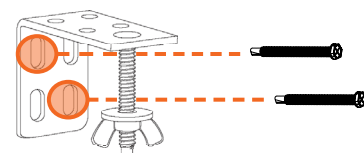
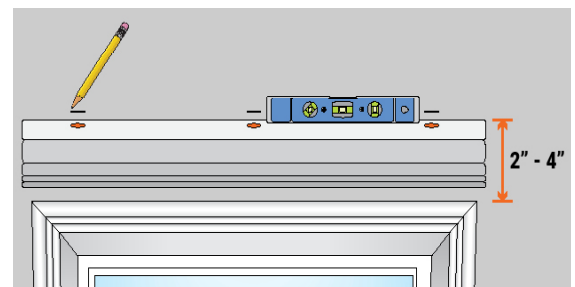

\*If you are using wall anchors, pre-drill with a 1/4" bit instead, and tap the wall anchors into the holes with a hammer before drilling in the screws.

## 2. ATTACHING THE SHADE

### INSIDE AND OUTSIDE MOUNT

**IMPORTANT:** The cords running along the underside of the headrail must be able to move freely. **To avoid tangling or damage to the cords, make sure the “wings” of the wingnut are facing the sides of the window.**

1. Remove the wingnuts from the brackets if you haven't done so already.

2. With the front of the shade facing you, fit the pre-drilled holes of the headrail to each of the drop-bolts on the brackets. While holding the headrail to the brackets with one hand, use your other hand to attach each of the wingnuts to the drop-bolts. Tighten the wingnuts until the shade is firmly held in place .

3. **IMPORTANT:** Please ensure that you fully close the headrail by attaching the headrail fabric together with the hook-and-loop fastening strip.

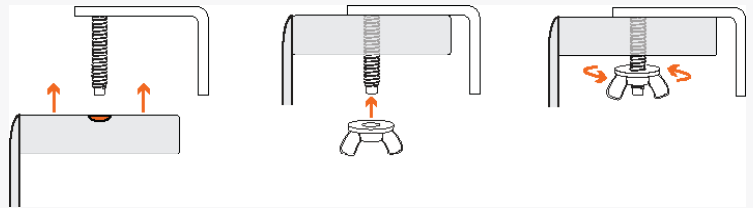
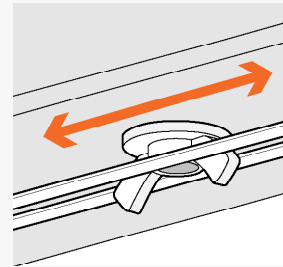

## 3. ATTACHING THE LIFT HANDLE

### CORDLESS ROMAN SHADES

**NOTE:** Cordless roman shades come with a clear plastic handle to help protect the fabric over multiple uses.

1. At the bottom pleat of the roman shade, locate the sewn-in hem bar.

2. Clip the handle to the center of the bottom hem bar.

3. To operate, grab the handle with your hand, and gently lift or lower the hem bar; the shade will stay in place when released.

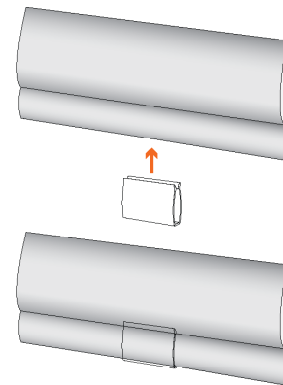

### CLEANING INSTRUCTIONS

**NOTE:** All fabrics are different and some may be easier to clean than others. We recommend cleaning your shades as often as once a month. Here are some general guidelines on how to do so:

1. For regular maintenance, use a duster or a vacuum with a brush attachment and run it over the front and back of the shade.
2. To spot clean stains, use a damp rag with a very mild, gentle detergent or soap. Dab at the affected spots; do NOT rub! Let the dampened area air-dry and repeat as necessary.
3. If your roman shade has wrinkles, you can use a basic steamer to remove them. Hold the steamer roughly six inches away from the fabric and wave the steamer back and forth over the wrinkled areas.

### WARRANTY AND REPLACEMENT

To learn more about our product warranties, please visit: <https://www.selectblindscanada.ca/warranty>

For replacement parts, and/or to file a warranty claim for a product that is damaged, defective, or missing parts, please call our Customer Care Team at 888-685-1735, or email [info@selectblindscanada.ca](mailto:info@selectblindscanada.ca).

## WARNING

**STRANGULATION HAZARD** — Young children can be strangled by cords. Immediately remove this product if a cord longer than 22 cm or a loop exceeding 44 cm around becomes accessible.

# ROMAN SHADES

## NO-TOOLS HEADRAIL

### 1. INSTALLING THE NO-TOOLS HEADRAIL

Hold the no-tools headrail up against the top of the recess, then push the lever firmly upwards until the rail snaps into place. If the rail is not quite tight enough then this can be easily adjusted:

At the end of the rail opposite to the lever there is an adjustment block that allows you to fine-tune the fitting of the rail. Use a flat-head screwdriver to twist the small red plugs in toward the center of the rail. Slide the block out of the rail by a few millimeters, then twist the red plugs back into their original position to fix the block in place. **Make small adjustments only**, repeating as necessary for a tight fit.

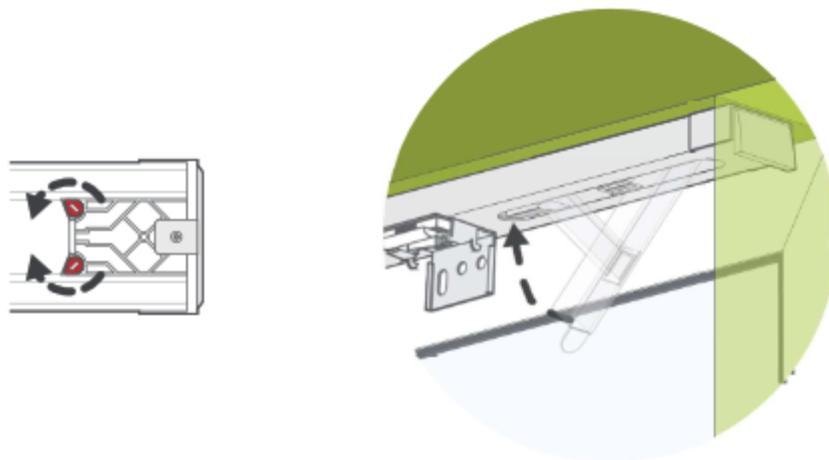

## WARNING

**STRANGULATION HAZARD** — Young children can be strangled by cords. Immediately remove this product if a cord longer than 22 cm or a loop exceeding 44 cm around becomes accessible.