



Roller Shade

Curved Cassette & Compact Curved Cassette Installation Instructions

 WARNING	 MISE EN GARDE
<p>STRANGULATION HAZARD — Young children can be strangled by cords. Immediately remove this product if a cord longer than 22 cm or a loop exceeding 44 cm around becomes accessible.</p>	<p>RISQUE D'ÉTRANGLEMENT — Les enfants en bas âge peuvent s'étrangler avec des cordes. Enlevez immédiatement ce produit si une corde mesurant plus de 22 cm devient accessible ou si le contour d'une boucle de plus de 44 cm devient accessible.</p>

NOTE: Fabric wrapped valances must be handled with care

1 PREPARATION

Curved Cassette

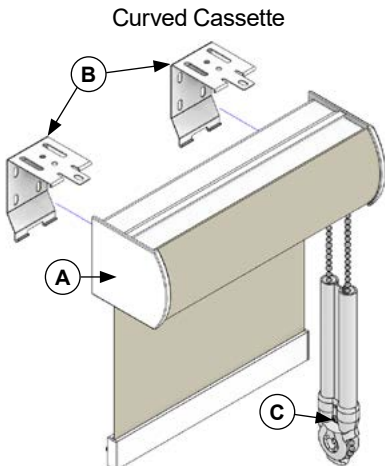

Compact Curved Cassette

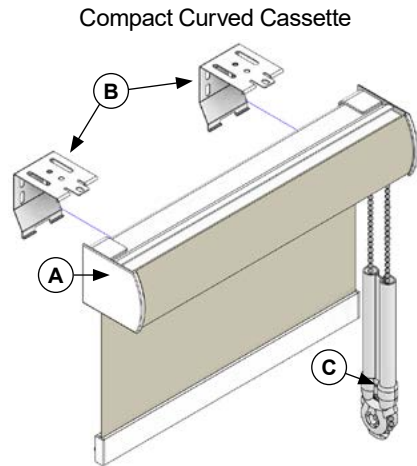

Component List

A. Shade
B. Mounting Brackets
C. Safety Shield

2 DETERMINE NUMBER OF BRACKETS

Shade Width	<60"	60" to 96"	96" to 120"	120" to 148"	>148"
# of Brackets	2	3	4	5	6

- Brackets should be no further than 2" from the ends of the cassette.
- The brackets should be equally spaced.
- The brackets should be installed level and aligned to each other. Shimming may be required.

3 MOUNT THE BRACKETS

CEILING MOUNT

leave a 1/4" between the wall and the mounting bracket

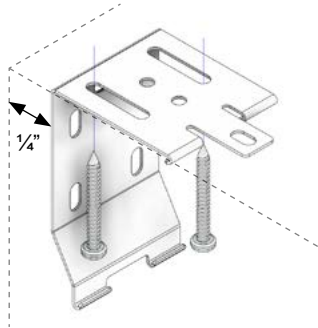

WALL MOUNT

leave a 1/4" between the ceiling and the mounting bracket

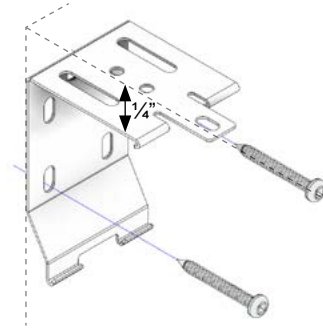

4 INSTALL THE SHADE

- (1) Insert the back edge of the cassette onto the bottom of each mounting bracket.
- (2) Starting from the center of the shade, push the cassette back and up until it snaps into the mounting bracket.
- (3) You will hear a click when the cassette snaps in to the mounting brackets.

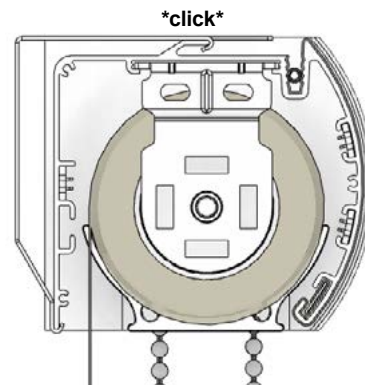
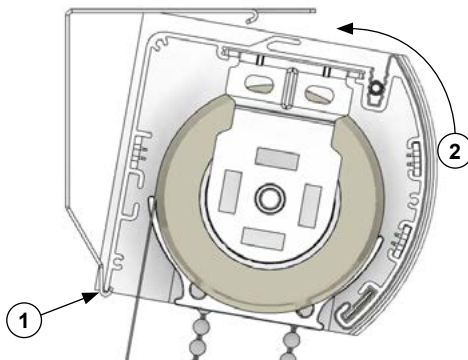

5 INSTALL THE SAFETY SHIELD

NOTE: For shades with chain operation only.

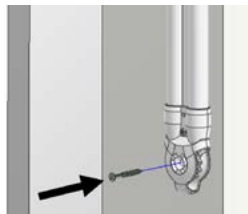

Roller Shade

3" and 4" Fascia

Installation Instructions



WARNING

STRANGULATION HAZARD — Young children can be strangled by cords. Immediately remove this product if a cord longer than 22 cm or a loop exceeding 44 cm around becomes accessible.



MISE EN GARDE

RISQUE D'ÉTRANGLEMENT — Les enfants en bas âge peuvent s'étrangler avec des cordes. Enlevez immédiatement ce produit si une corde mesurant plus de 22 cm devient accessible ou si le contour d'une boucle de plus de 44 cm devient accessible.

NOTE: Fabric wrapped valances must be handled with care

1

PREPARATION

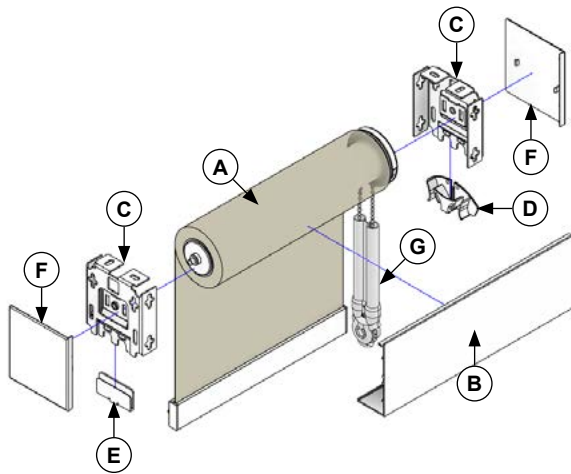

Component List

- A. Shade
- B. Fascia
- C. Mounting Bracket
- D. Chain Diverter
- E. Chain Diverter Placeholder
- F. Bracket Cover (Optional)
- G. Safety Shield

2

MOUNT THE BRACKETS

Ensure a 1/8" gap is left on each side for end caps.

CEILING MOUNT

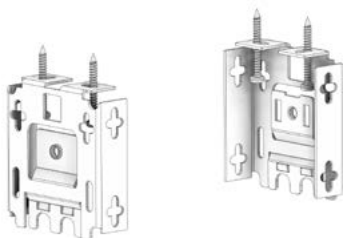

WALL MOUNT

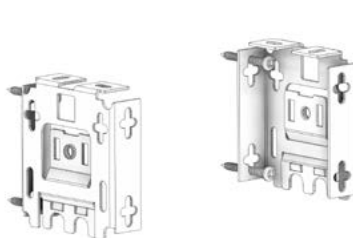

LATERAL MOUNT

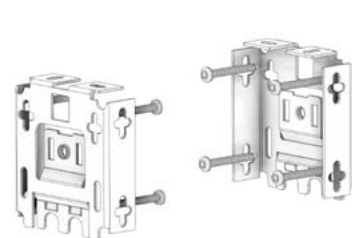

3 INSTALL THE SHADE

NOTE: For shades with Zero Gravity, please refer to Zero Gravity instructions on page 3.

STEP 3A: INSTALL PIN END

Install the Pin End into the hole in the bracket.

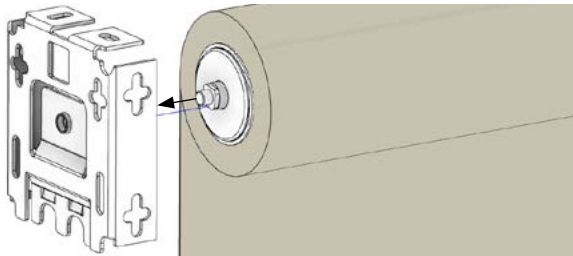

STEP 3C: INSTALL CLUTCH END

While keeping pressure against the Pin End hook the clutch onto the other bracket.

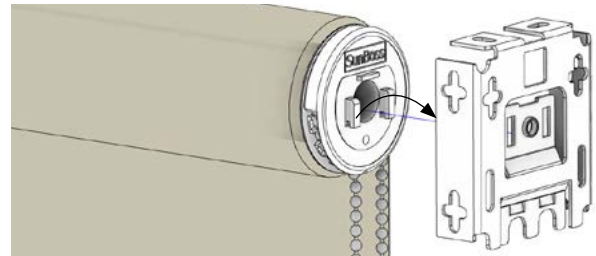

4 INSTALL THE CHAIN DIVERTER

Insert the chain into the channels as shown below. Then insert click the chain diverter and placeholder into the mounting brackets.

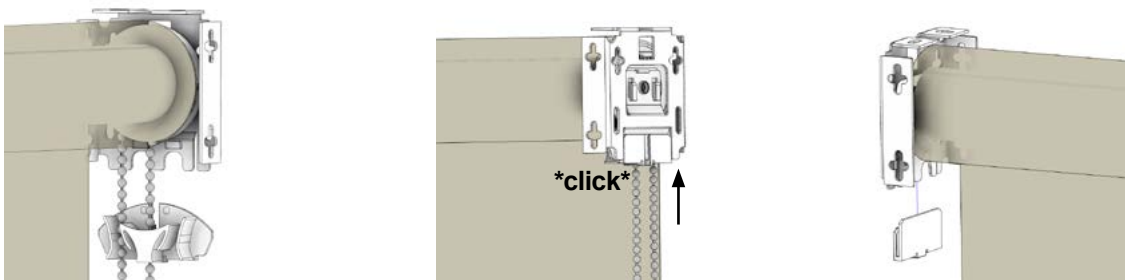

5 INSTALL THE FASCIA

First, snap the bracket covers on, then hook the fascia on the top of the mounting brackets, then swing the bottom of the fascia down until it clicks.

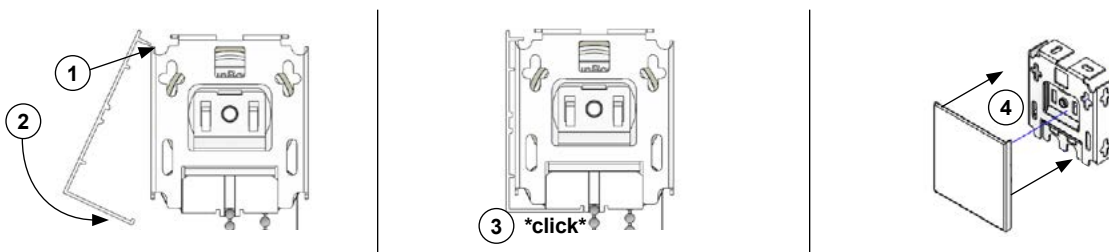

6 INSTALL THE SAFETY SHIELD

NOTE: For shades with chain operation only.

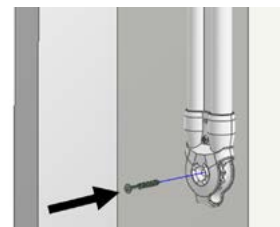

If the Pin End of the shade appears as shown here, proceed with **Steps 1,2 & 3** before returning to **Step 4** of the **Open Roll or Fascia Installation Instructions**



If the Pin End of the shade appears as shown here, proceed with **Steps 4,5 & 6** before returning to **Step 4** of the **Open Roll or Fascia Installation Instructions**



1 REMOVE THE SHIPPING LOCK



Remove shipping lock

2 INSTALL THE SHADE

- (A) Install the Pin End into the hole in the bracket.
- (B) While keeping pressure against the Pin End hook the clutch onto the other bracket.

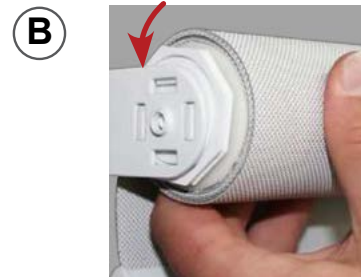
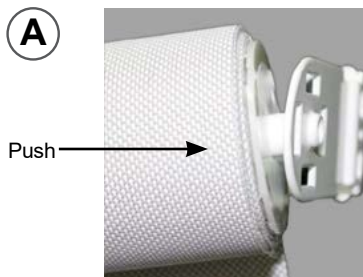

3 TEST THE SYSTEM

Draw and raise the shade from the middle of the bottom bar.

To increase tension use the spanner to turn the head in the opposite direction that the fabric falls off of the roll. To decrease tension turn toward the direction that the fabric falls off of the roll.



Adjusting Spanner

⚠ WARNING

- Do not pull pin lock out until shade is installed or tension will be released.
- If tension has been released, see troubleshooting.

4 REMOVE RUBBER BAND

Remove the rubber band holding the Pin Lock in place.



5 INSTALL SHADE AND REMOVE PIN LOCK

Install the shade while keeping Pin Lock toward you and held in place, then remove the pin lock.

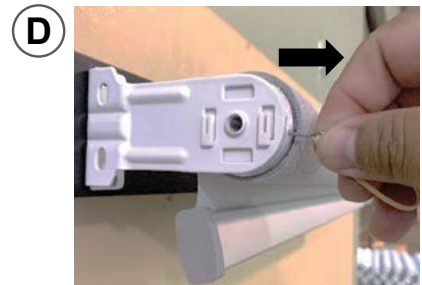

6 TESTING THE SYSTEM

Pull and lift the shade from the middle of the bottom bar.



TROUBLE SHOOTING IF TENSION IS RELEASED

To increase tension, use the spanner to turn the head in the opposite direction that the fabric falls off of the roll (approximately 1 – 2 full rotations). Insert the pin Lock into the hole of the clutch while holding the shade to keep the tension. **PROCEED WITH STEP 5 WHEN FINISHED.**

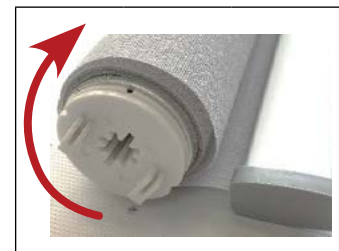

Roller Shade

Open Roll

Installation Instructions



WARNING

STRANGULATION HAZARD — Young children can be strangled by cords. Immediately remove this product if a cord longer than 22 cm or a loop exceeding 44 cm around becomes accessible.



MISE EN GARDE

RISQUE D'ÉTRANGLEMENT — Les enfants en bas âge peuvent s'étrangler avec des cordes. Enlevez immédiatement ce produit si une corde mesurant plus de 22 cm devient accessible ou si le contour d'une boucle de plus de 44 cm devient accessible.

1

PREPARATION

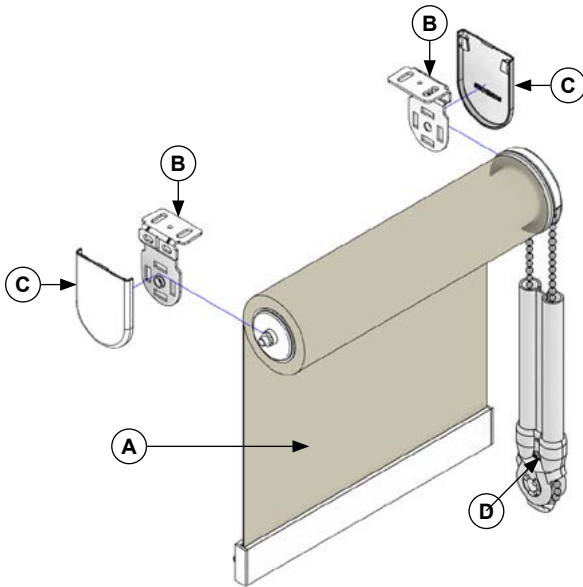

Component List

- A. Shade
- B. Universal Mounting Bracket
- C. Bracket Cover (Optional)
- D. Safety Shield

2

MOUNT THE BRACKETS

CEILING MOUNT

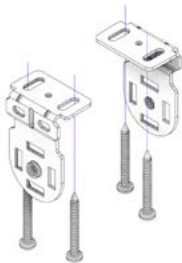

WALL MOUNT

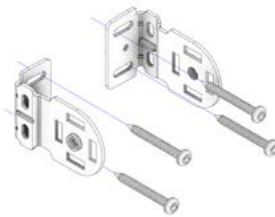

LATERAL MOUNT



3 INSTALL THE SHADE

NOTE: For shades with Zero Gravity, please refer to the instructions on the following pages

STEP 3A: INSTALL PIN END

Install the Pin End into the hole in the bracket.



STEP 3B: INSTALL CLUTCH END

While keeping pressure against the Pin End hook the clutch onto the other bracket.

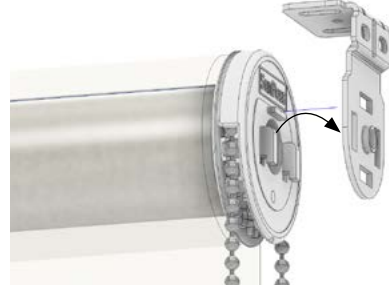

4 INSTALL BRACKET COVERS (OPTIONAL)

If you were supplied with bracket covers, slide them on to the mounting brackets.

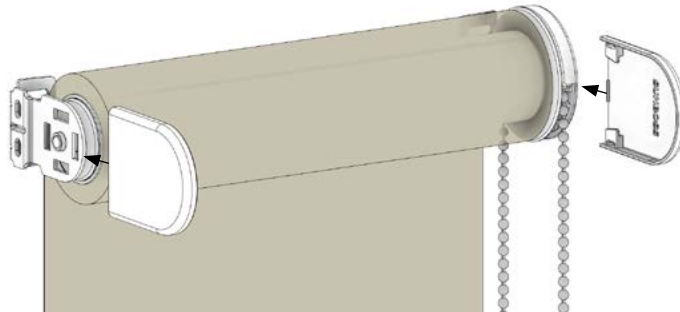

5 INSTALL THE SAFETY SHIELD

NOTE: For shades with chain operation only.

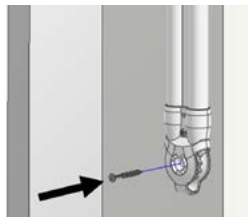

If the Pin End of the shade appears as shown here, proceed with **Steps 1,2 & 3** before returning to **Step 4** of the **Open Roll or Fascia Installation Instructions**



If the Pin End of the shade appears as shown here, proceed with **Steps 4,5 & 6** before returning to **Step 4** of the **Open Roll or Fascia Installation Instructions**



1 REMOVE THE SHIPPING LOCK



Remove shipping lock

2 INSTALL THE SHADE

- (A) Install the Pin End into the hole in the bracket.
- (B) While keeping pressure against the Pin End hook the clutch onto the other bracket.

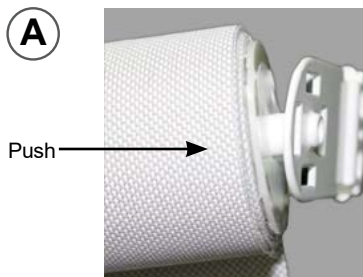

3 TEST THE SYSTEM

Draw and raise the shade from the middle of the bottom bar.

To increase tension use the spanner to turn the head in the opposite direction that the fabric falls off of the roll. To decrease tension turn toward the direction that the fabric falls off of the roll.



Adjusting Spanner

⚠ WARNING

- Do not pull pin lock out until shade is installed or tension will be released.
- If tension has been released, see troubleshooting.

4 REMOVE RUBBER BAND

Remove the rubber band holding the Pin Lock in place.



5 INSTALL SHADE AND REMOVE PIN LOCK

Install the shade while keeping Pin Lock toward you and held in place, then remove the pin lock.

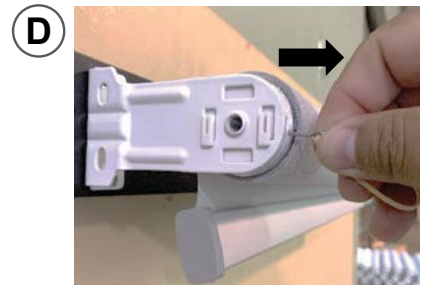

6 TESTING THE SYSTEM

Pull and lift the shade from the middle of the bottom bar.



TROUBLE SHOOTING IF TENSION IS RELEASED

To increase tension, use the spanner to turn the head in the opposite direction that the fabric falls off of the roll (approximately 1 – 2 full rotations). Insert the pin Lock into the hole of the clutch while holding the shade to keep the tension. **PROCEED WITH STEP 5 WHEN FINISHED.**

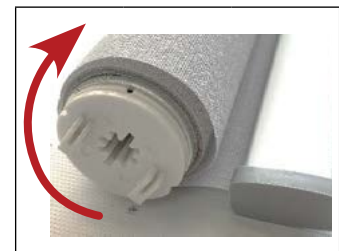

Stealth Rechargeable Programming Instructions

01 Product Info

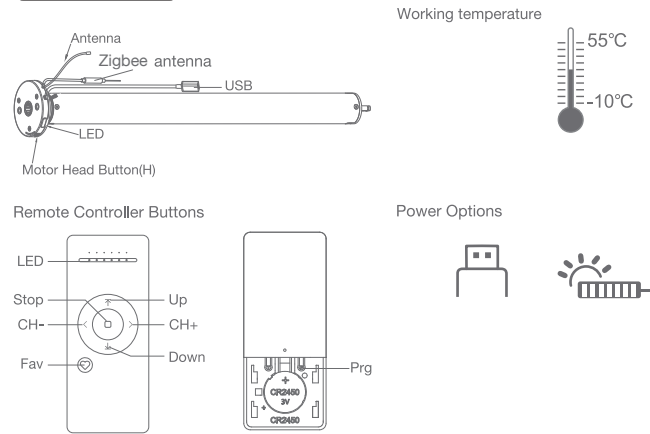

02 Caution!



- 1.This product is for indoor use only, do not use outdoor or in humid environments.
- 2.This motor has a built-in rechargeable Li-Ion battery pack with integrated charge management. Max input voltage: 5V/2A.
- 3.Please charge it before using for the first time, make sure it is fully charged before first use
- 4.When the battery voltage is low, LED will flicker 8 times to give a low-voltage alarm when motor starts.
- 5.The motor will jog in operation, please do not proceed to the next step until it is complete.
- 6.During operation, the effective interval of the transmitter button operation is 10 seconds. If there is no effective transmitter operation for more than 10 seconds, it will automatically exit the current mode.
- 7.The motor can be paired with max 10 controllers.
- 8.Please do not use motor when charging.
- 9.Upper&Lower limits cannot be set at the same position, limits will be saved even in power off.
- 10.The motor will run constantly for 6 mins if limits have not been set and no other operation is performed.
- 11.Do not lift the motor by grabbing the wire or antenna.

- 12.As a standard, motors are shipped in factory default mode without limits set.
- 13.Channel "0" cannot be programmed on a multi channel remote. It is intended to be a master channel for all motors.

03 Instructions

Motor head button (H) functions

Functions	Operation	Jogging time	LED lamp flickers	Note
Control the UP/STOP/DOWN of the Shade	Short press	/	/	Can only operate after the limits are set and motor is not in sleep mode
Adding/Removing Controller	Hold for 2s	Jog x1	Flicker x1	Operation needs be done within 10s
Zigbee Connecting	Hold for 6s	Jog x2	Flicker x2	Entering Zigbee connection mode
Direction Reverse	Hold for 10s	Jog x3	Flicker x3	All settings saved after direction reversed
Reset	Hold for 16s	Jog x4	Flicker x4	All settings deleted

a.Pairing Motor with Controller

Way 1: Power on, add a new controller

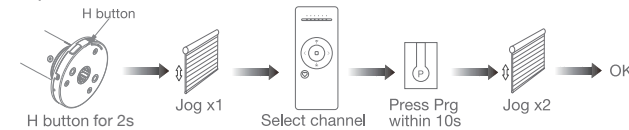

Way 2: Power on, add controller B via pre-existing controller A

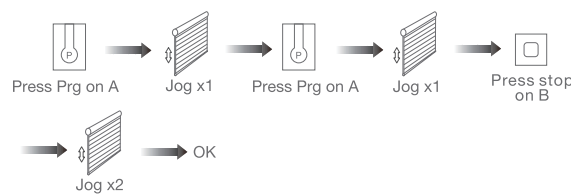

Note: Pairing can not be done under group channel or 0 channel.

b.Direction Reverse

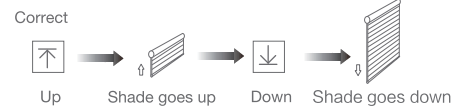

If the limits are not set, and direction goes opposite.

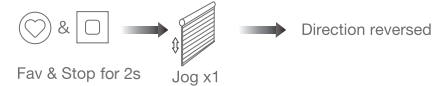

If limits are set and direction goes opposite.



Note: Do reverse the direction when it goes opposite.

c.Upper&Lower Limits Setting



Note: Upper&Lower limits cannot be set at the same point.

Before limits set, the motor will run in one-touch mode by pressing Up or Down, Hold Up or Down for 2s, motor runs in constant-touch mode. Once limits set, press Up or Down, motor runs in constant-touch mode.



d.One-touch/Constant-touch Mode

Constant-touch ----->One-touch

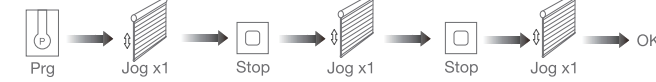

Same operation can toggle from one-touch to constant-touch mode.

Note: When motor is in one-touch mode, hold Up or Down for more than 2s, it will run in constant-touch mode.

e.Setting and Cancelling Favorite Position



f.Hot key to the Fav. Position

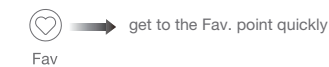

Note: The Fav.position setting only can be done after upper&lower limits set.

g.Adjusting Upper & Lower Limits

Adjust Upper limit

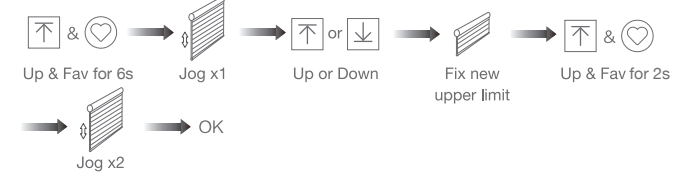

Adjust Lower limit

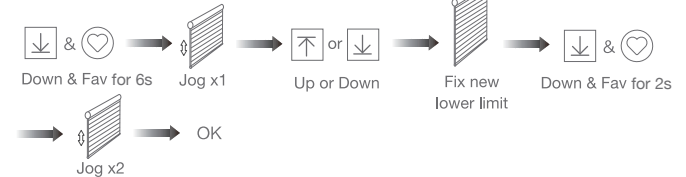

Note: The operation should be done within 4mins.

h.Adjusting Motor Speed

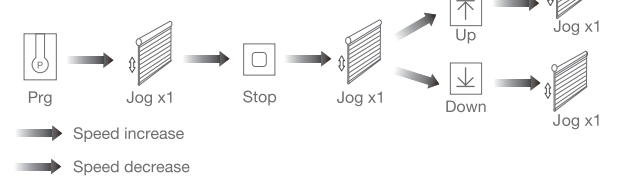

Note: If motor doesn't jog, the max/min speed has already been reached. There are 3 adjustable speeds.

i.Removing Controllers

Remove a single controller



Remove controller B via pre-existing controller A

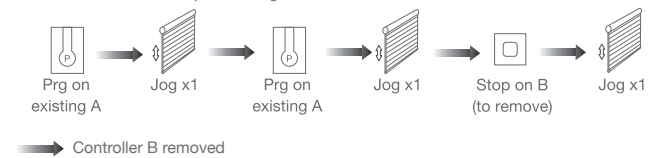

Remove all controllers:

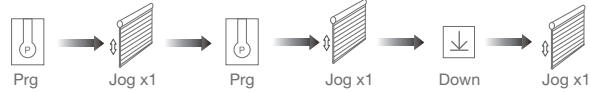

➡ All controllers removed

Note: All the settings are saved even controllers removed(limits set are saved).
Controller A/B are already paired to motor.

j.Cancelling Limits

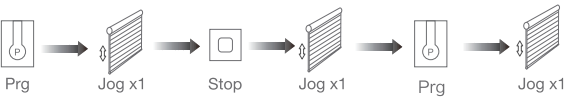

➡ Limits cancelled

Note: It is forbidden to run the motor if installed into the shade without limits.
Limits should be set immediately to protect the shade.

k.Zigbee Connecting

*Connection requirement

- Make sure the phone is connected to the Wi-Fi network.
- The Tuya Zigbee gateway device needs to be added to the "Smart Life" APP first, please refer to its manual for details.

① Download App

- Search for "Smart Life" in the app store or scan the QR code



- Complete account registration and login to the app

② Add Device

- Make sure the phone is connected to the Wi-Fi network
- Make sure the Tuya Zigbee gateway device is connected to "Smart Life" App
- Make the motor is ready to be connected to Zigbee by following steps:

Way 1

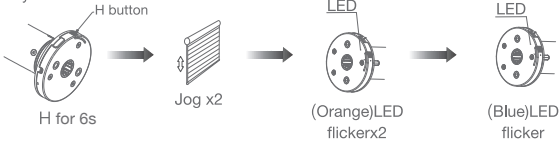

➡ Zigbee connecting

Way 2:

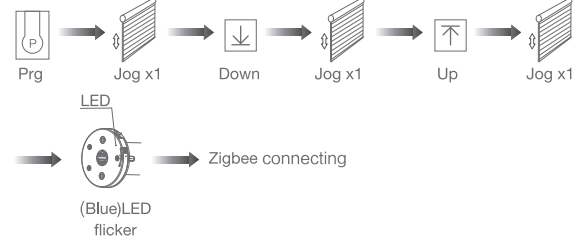

- Find the added Tuya Zigbee gateway on the "Smart Life" App, click "+" to add a sub-device, and then click "LED already blink", the APP will automatically search for motor device

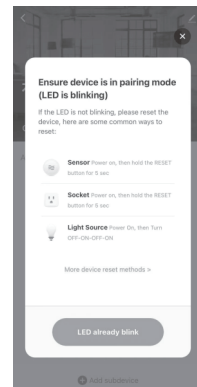
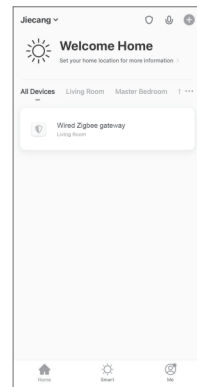

- After adding successfully, click "✎" to modify the device name

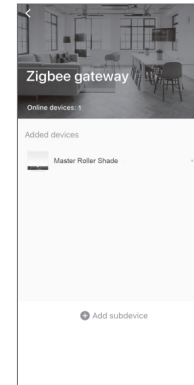
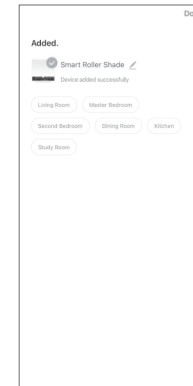
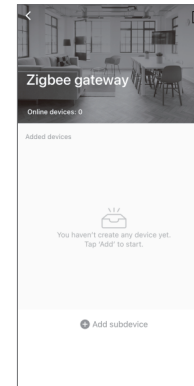

- After the motor device is added successfully, the LED on motor head will be on for 10s and then go off.



- Now the motor can be controlled by App from anywhere, anytime

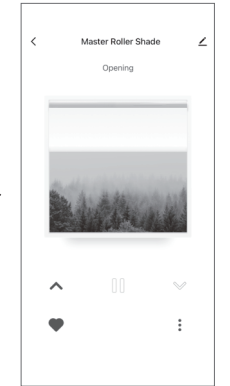
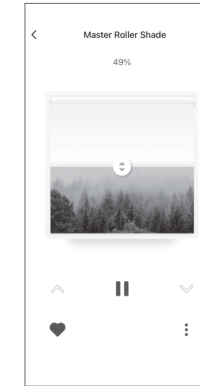

04 Troubleshooting

Fault	Cause	Solution
Motor does not work	1.Controller not paired 2.Motor inactive 3.Low battery	1.Add controller 2.Hold H button for 2s to activate motor 3.Charging
Motor stops suddenly	1.Upper & Lower limit set incorrectly 2.Shade exceed rated load 3.Low battery	1.Re-set Upper & Lower limits 2.Adjust load 3.Charging
LED flickers 8 times on motor head when motor starts	Low battery	Charging

SETUP CODE CODE DE CONFIGURATION

SBCAN

Getting to know your Smart Controller

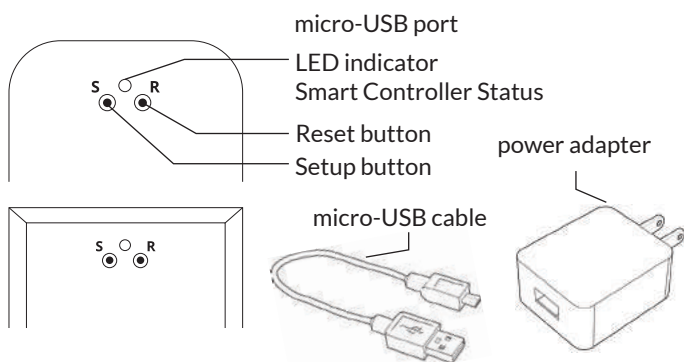

Smart Controller Status:
Flashing blue - Hotspot available
Flashing green - Connecting to the WiFi network
Pulsing cyan/blue-green - Connected to the Internet

Getting Started

- 1 Download the Neo Smart Blinds app**

Download the app to your phone or tablet by searching **Neo Smart Blinds** on Google Play or the App Store.
Note: Do not install Neo Smart Blinds Blue
- 2 Plug in your Smart Controller in reach of your home WiFi**

Choose a place not too far from your home router or a place you know has good WiFi signal strength. You will be able to change its location after, if necessary.
- 3 Create an account and choose the setup code written on the cover**

After opening the app, tap on Create one to create a new account. Enter a valid email address and choose a password, select the region time zone from the place where the Smart Controller will be located. Choose the setup code written in the cover and tap on Register.
- 4 Follow the app step by step to add the Smart Controller**

Have in hand the home WiFi password. It will be necessary to connect the Smart Controller to the Internet.
Note: Some Android users won't be connected quickly to the hotspot. If it is the case, please wait about 10 seconds before returning to the app. During this time, your device may notify you that the hotspot does not have Internet access, and will prompt you whether you want to remain connected. You need to select the option that will allow you to keep connected before returning to the app.

System requirements

- A strong WiFi signal (3 bars or more) in the location where you will setup your Smart Controller.
- The Smart Controller only supports 2.4GHz WiFi (IEEE 802.11b/g/n), not 5GHz. WiFi security needs to be set to WPA-PSK or WPA2-PSK.
- A smartphone or tablet running Android 5.0 (Lollipop) or higher, or iOS 8 or higher is needed.

Troubleshooting

The home WiFi doesn't appear in the step 4

Try rescanning, if the problem persists, you will need to reposition the Smart Controller to a place with stronger WiFi signal. In this case, exit the process (tap on the menu, then tap Your Rooms), replace the Smart Controller and start over.

The Smart Controller LED in the bottom is not blinking blue

The process fails in the last step

Press the S button for 10 seconds, then press the R button once and start over. Pay special attention when typing the WiFi password.

Need more help?

Visit neosmartblinds.com/smartcontroller for detailed instructions about how to use the app and troubleshooting.

Integrations

Smart home devices

Visit neosmartblinds.com/smartcontroller-integrations for detailed information about connecting to Amazon Alexa, Google Home and other systems.

Control4

Please send an email to tech@neosmartblinds.com with your name, your email and your company's name. This information is necessary to always send to you any further driver update.

Legal Information

FCC

This equipment has been tested and found to comply with the limits for a Class B digital device, pursuant to Part 15 of the FCC Rules. These limits are designed to provide reasonable protection against harmful interference in a residential installation. This equipment generates uses and can radiate radio frequency energy and, if not installed and used in accordance with the instructions, may cause harmful interference to radio communications. However, there is no guarantee that interference will not occur in a particular installation. If this equipment does cause harmful interference to radio or television reception, which can be determined by turning the equipment off and on, the user is encouraged to try to correct the interference by one of the following measures:

- Reorient or relocate the receiving antenna.
- Increase the separation between the equipment and receiver.
- Connect the equipment into an outlet on a circuit different from that to which the receiver is connected.
- Consult the dealer or an experienced radio/TV technician for help

Contains transmitter module FCC ID: COFWNMNB11

To comply with FCC/IC RF exposure limits for general population/ uncontrolled exposure, the antenna(s) used for this transmitter must be installed to provide a separation distance of at least 20 cm from all persons and must not be co-located or operating in conjunction with any other antenna or transmitter.

IC

This device complies with Industry Canada's licence-exempt RSSs. Operation is subject to the following two conditions:

- This device may not cause interference; and
- This device must accept any interference, including interference that may cause undesired operation of the device.

This device meets the exemption from the routine evaluation limits in section 2.5 of RSS102 and users can obtain Canadian information on RF exposure and compliance.

Contains transmitter module IC: 10293A-WMNB11

This End equipment should be installed and operated with a minimum distance of 20 centimeters between the radiator and your body.

